



**ROADWIN**

*Stay on your way*

**DISC BRAKE PADS**



“O.E.M and other manufacturers names, part numbers and images are used for reference only”

# PREMIUM CLASS BRAKE PADS

To make sure of the quality and not to disappoint Customers, brake pads are tested by accredited testing laboratory performing the test on the basis of the engineer Peter Krauss method. All pads are always tested in identical conditions - the contact area, the pressing force, the disk rotation speed are always the same. The obtained data (material wear, abrasion and friction coefficients, the operating temperature, the impact on disc) is analysed and the comparative results are presented.

One of the main characteristics - the friction coefficient curve - shows the change of braking efficiency when braking conditions become more difficult, when the braking temperature rises. When braking on highway from 100 km/h to a full stop pads heat up to 500°C; in the mountains even more.

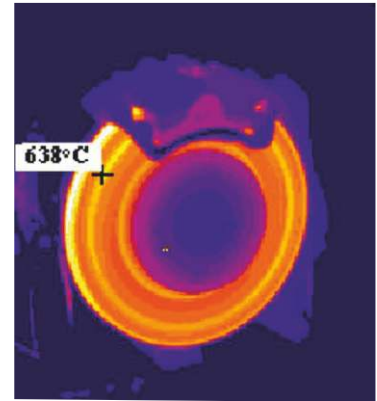
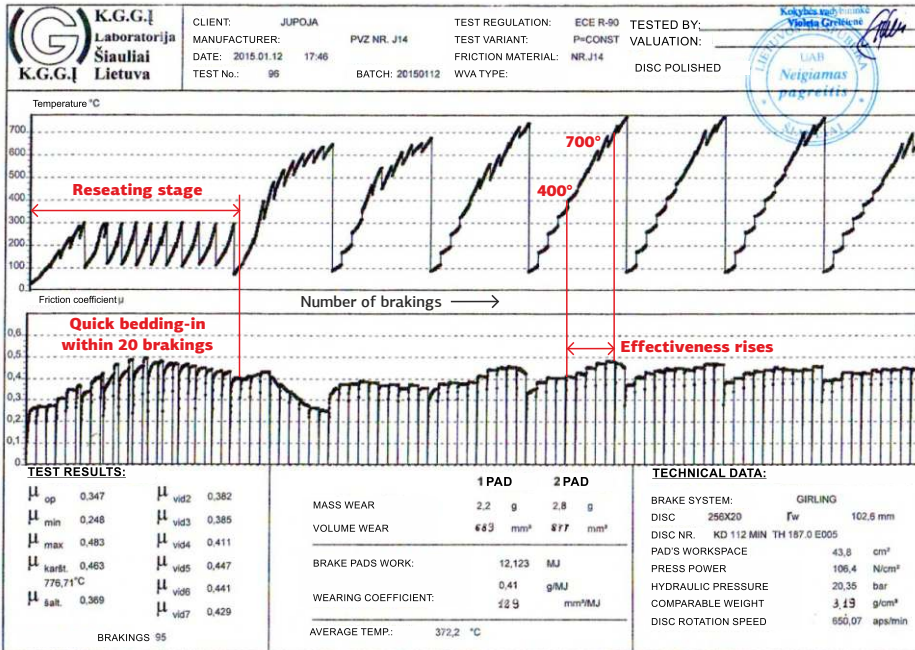

## Other test results

Compared with other manufacturers' pads under the same conditions, RW Premium pads:

- ☑ **don't grind the disc** - surface remains specular
- ☑ **minimal noise**
- ☑ **Braking efficiency increases** with the rise of working temperature - important on highways and mountains
- ☑ Due to the good abrasion coefficient Roadwin pads **longevity equals** accepted producer pads
- ☑ New pads **quickly bed-in** and achieve the best working performance

### Maximum work temperature

The higher the working temperature, the better the pads brake and the **stopping distance is shorter**

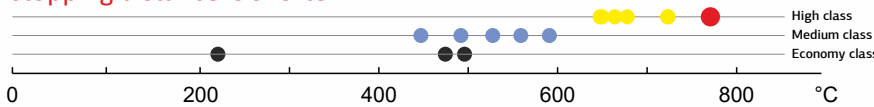

### Braking effectiveness

If the friction coefficient with increasing temperature rises, **the braking is improving** in difficult conditions, for example, driving down the hill

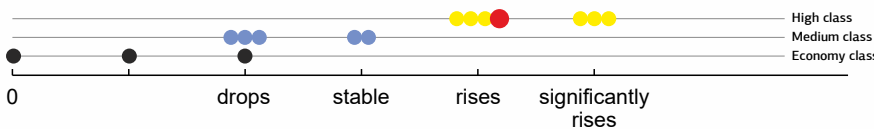

### Low rate of wear

Lower the rate is, **less the pads wear and last longer**

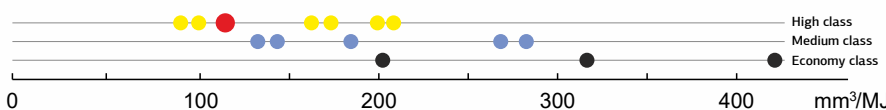



- ROADWIN PREMIUM brake pads
- High class brake pads, made by well-known accepted manufacturers
- Medium class brake pads
- Cheap, economy class brake pads

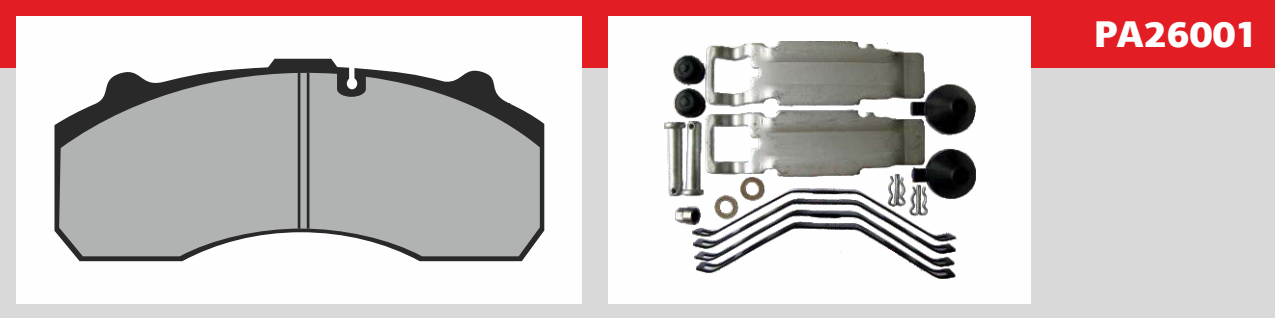



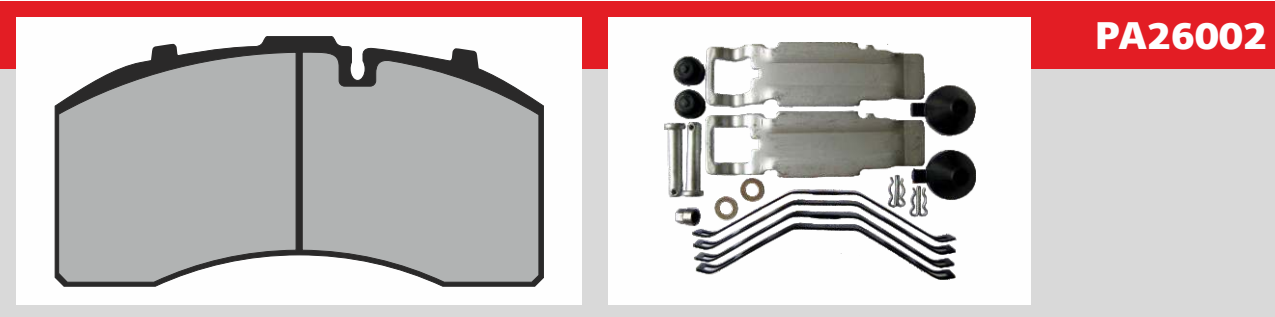
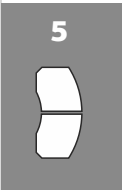

**PA26001**

Suitable for	Cross-ref.	 mm	 mm	 mm	Quantity, pcs/set	Notes
WVA	29059, 29061 29087, 29105 29108, 29179 29202	247,5	109,5	30	4	Top springs included Repair kit included
BPW	0980106360					
DAF	1617343					
IV	2992348					
MAN	81508206032					
MB	0004210510					
Neoplan	082135100					
SAF	3057007700					
SC	1390428					



**PA26002**

Suitable for	Cross-ref.	 mm	 mm	 mm	Quantity, pcs/set	Notes
WVA	29158, 29171 29178, 29193 29194	210,2	107,8	30	4	Top springs included Repair kit included
BPW	0509290060 0509290080 0980106440 0980106950					
MB	0044207020					
SAF	3057008500					

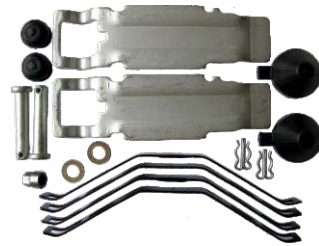
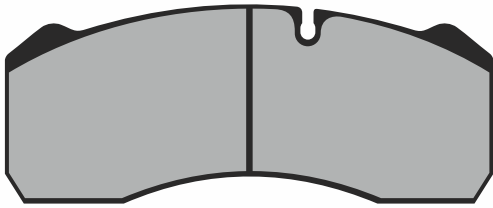

## 5.3 DISC BRAKE PADS

**PA26003**







5

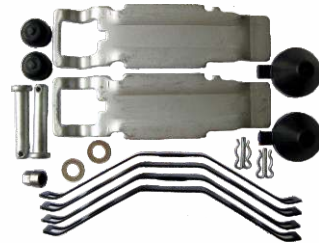
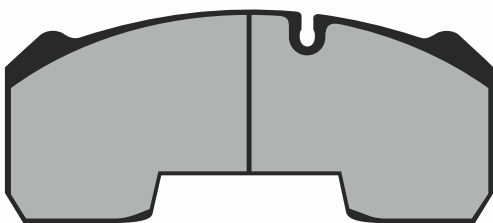

Suitable for	Cross-ref.	 mm	 mm	 mm	Quantity, pcs/set	Notes
WVA	29093, 29094 29095, 29096 29145, 29184	210,4	92,5	30	4	Top springs included Repair kit included
BPW IV MAN MB	098010275029 92336 81508205017 0004210710 0024207820 0024207920					
SAF	3057007800					



**PA26006**

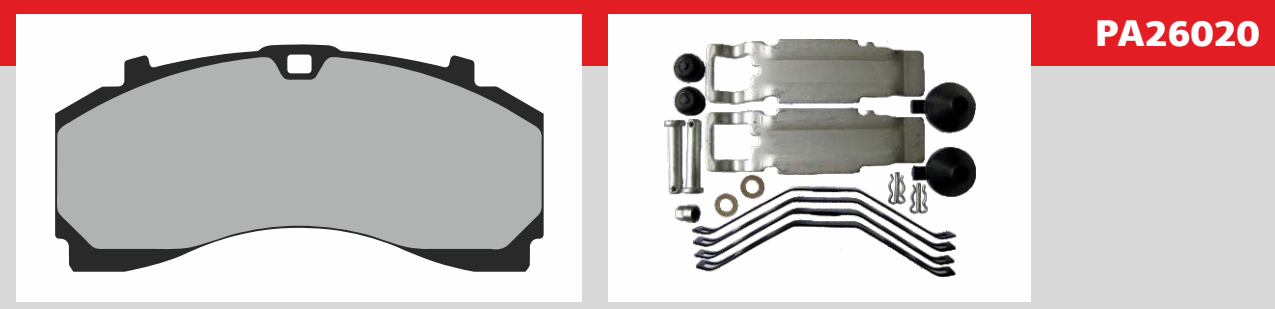

Suitable for	Cross-ref.	 mm	 mm	 mm	Quantity, pcs/set	Notes
WVA BPW	29165 0509290040 0509290050 0509290100 0980102750 0980102930 0980106210 0980106350 0980106430 0980107090	210,4	92,5	30	4	Top springs included Repair kit included



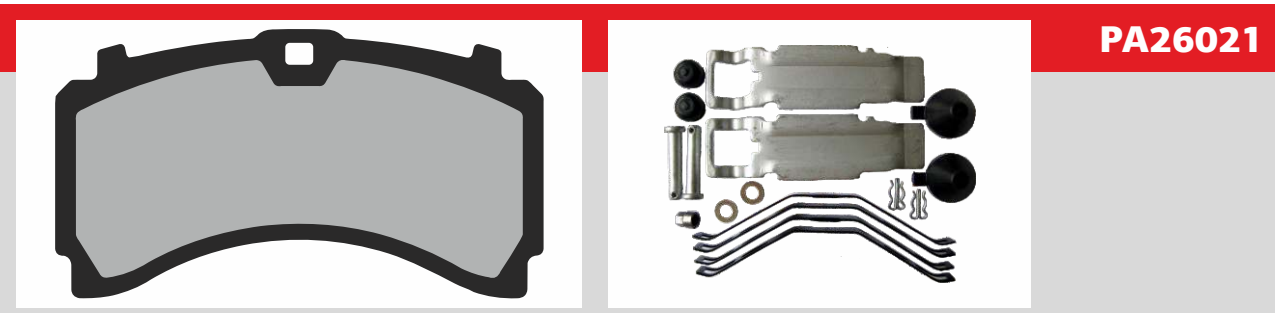
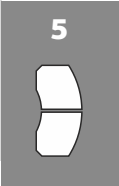

**PA26020**

Suitable for	Cross-ref.	 mm	 mm	 mm	Quantity, pcs/set	Notes
WVA	29246	244,2	113	35	4	Top springs included Repair kit included
MB	0064201420					



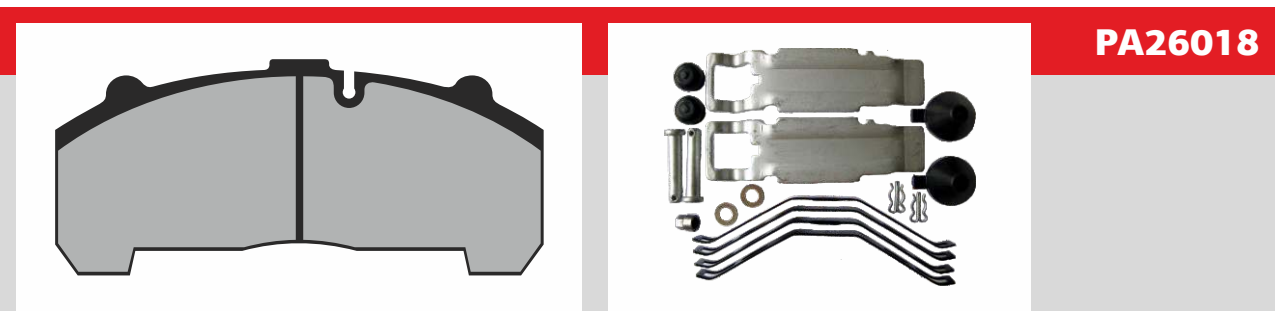

**PA26021**

Suitable for	Cross-ref.	 mm	 mm	 mm	Quantity, pcs/set	Notes
WVA	29244	207,2	107,8	35	4	Top springs included Repair kit included
MB	0064201520					







**PA26018**

Suitable for	Cross-ref.	 mm	 mm	 mm	Quantity, pcs/set	Notes
WVA BPW	29167 0509290070 0509290090 0536270020 0980102570 0980102920 0980106200 0980106360 0980106450 0980106960	247,4	109,5	30	4	Top springs included Repair kit included

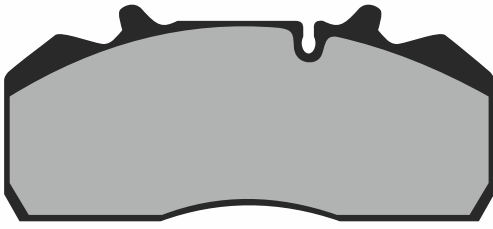
## 5.5 DISC BRAKE PADS



### PA26005



Suitable for	Cross-ref.	 mm	 mm	 mm	Quantity, pcs/set	Notes
WVA DAF SAF	29126, 29156 29159 1628064 305700800	210,2	92,3	30	4	Top springs included Repair kit included

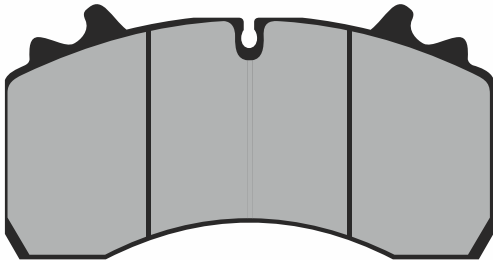

### PA26009



Suitable for	Cross-ref.	 mm	 mm	 mm	Quantity, pcs/set	Notes
WVA SAF	29162 3057008400	210,5	109,5	31	4	Top springs included Repair kit included

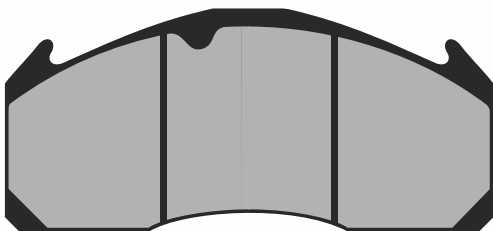

### PA26004

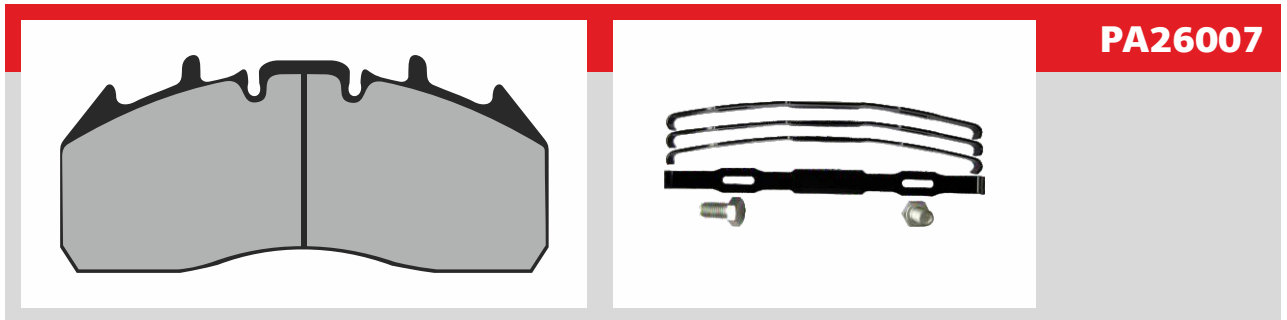

Suitable for	Cross-ref.	 mm	 mm	 mm	Quantity, pcs/set	Notes
WVA VL	29125 20768092 20918891 3095396 20931343 20932682	249,4	111,2	29,25	4	Top springs included Repair kit included



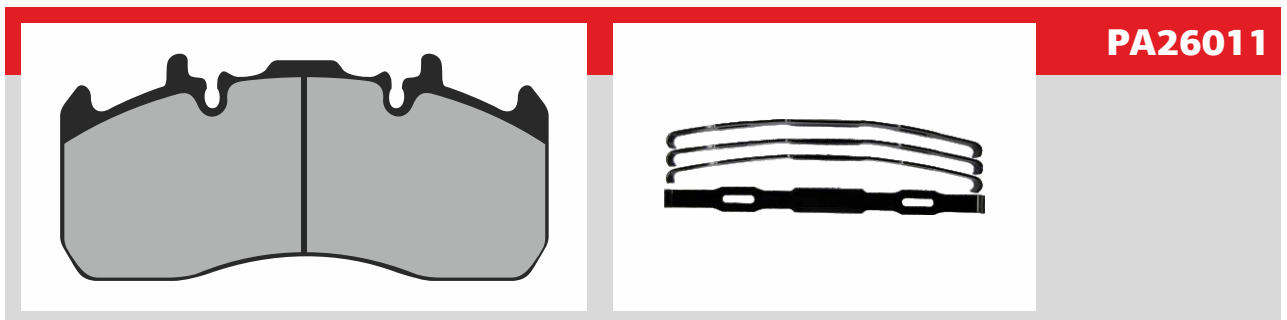

**PA26007**

Suitable for	Cross-ref.	 mm	 mm	 mm	Quantity, pcs/set	Notes
WVA RVI VL	29174 5001864363 5001864364 20568711 20568714	249,6	106,9	29,25	4	Top springs included Repair kit included



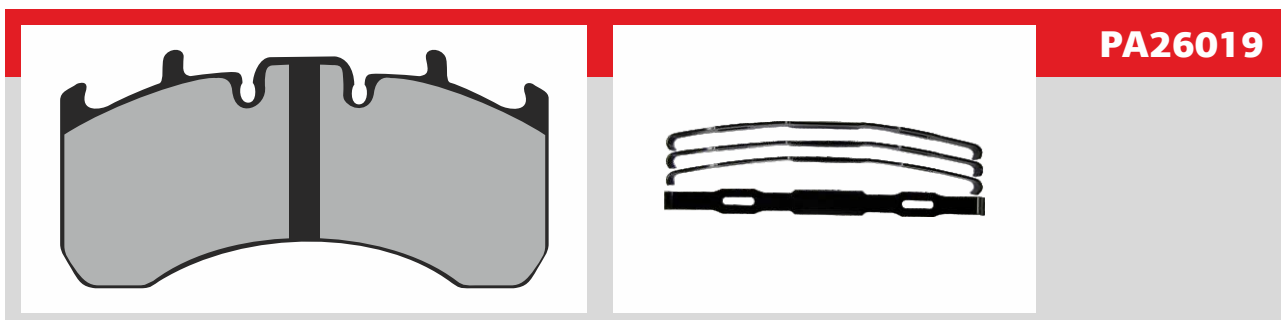

**PA26011**

Suitable for	Cross-ref.	 mm	 mm	 mm	Quantity, pcs/set	Notes
WVA RVI VL	29173 5001864365 20568712 20568715	216,2	97	29,2	4	Top springs included



**PA26019**

Suitable for	Cross-ref.	 mm	 mm	 mm	Quantity, pcs/set	Notes
WVA Meritor RVI VL	29177 68324665 5001864380 20568713 20765963	210,4	99,8	30	4	Top springs included

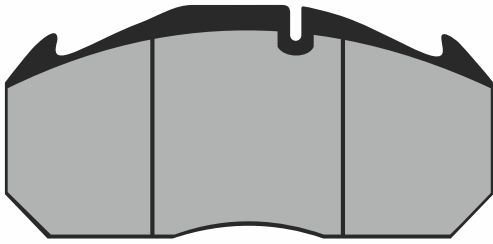

## 5.7 DISC BRAKE PADS

**PA26008**







5

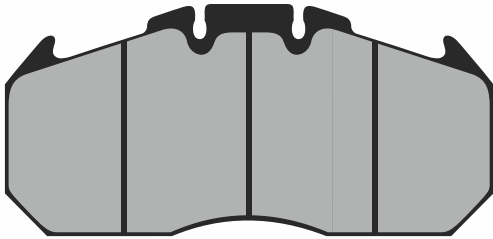

Suitable for	Cross-ref.	 mm	 mm	 mm	Quantity, pcs/set	Notes
WVA	29030, 29083 29084, 29113 29210	249	118,1	28	4	Top springs included
MAN	81508205047 81508206014					
MB	0024200820					
RVI	5001823000					



**PA26010**





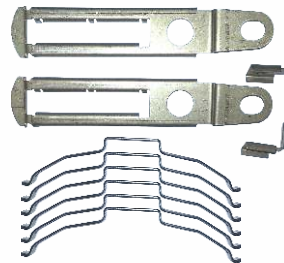
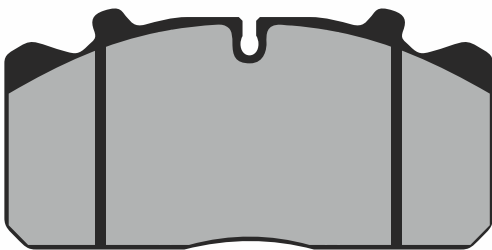

Suitable for	Cross-ref.	 mm	 mm	 mm	Quantity, pcs/set	Notes
WVA MAN	29131 81508205072 81508205080 81508206041 81508206051	249,3	117,9	32	4	Top springs included
RVI	5001855646 5001020312 5006028410					

**PA26012**

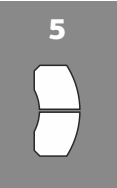
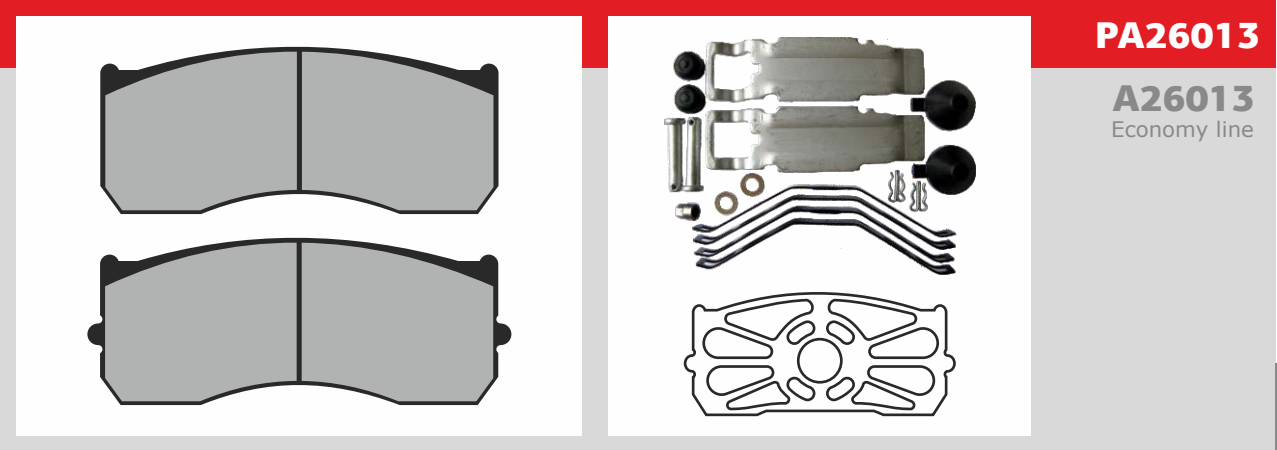



Suitable for	Cross-ref.	 mm	 mm	 mm	Quantity, pcs/set	Notes
WVA DAF IV MAN	29088, 29091 1436901 1906467 81508205023 81508205029 81508205025	175,6	86,4	26	4	Top springs included Repair kit included Sensors included
RVI	5010848607					

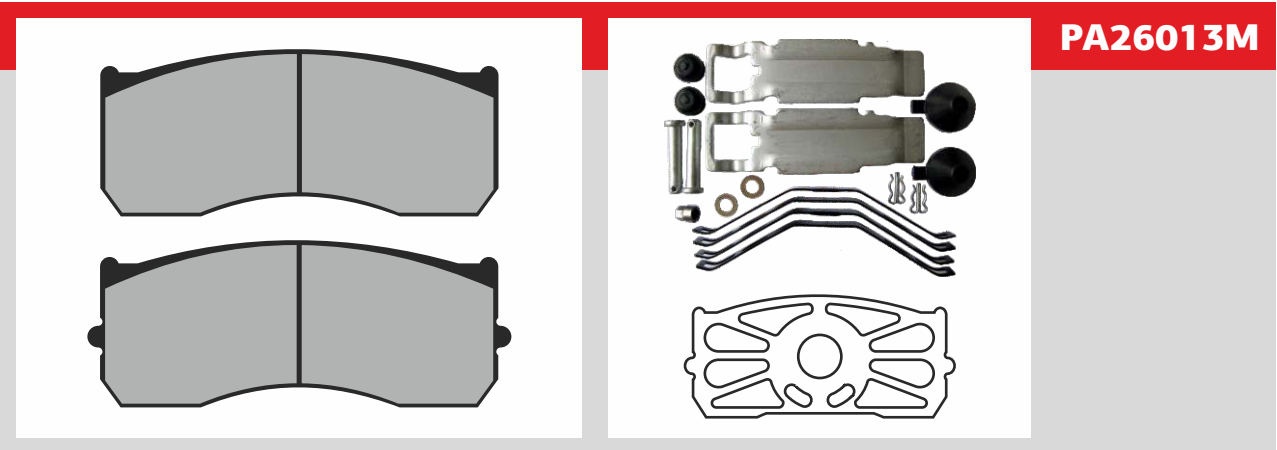

Suitable for	Cross-ref.	 mm	 mm	 mm	Quantity, pcs/set	Notes
WVA	29115, 29116 29148, 29183	185	85	15	4	Top springs included Repair kit included
MAN	81508205085 81508206054					
MB	0004211010 0004211210 0014212510 0034201120 0034201220					





Suitable for	Cross-ref.	 mm	 mm	 mm	Quantity, pcs/set	Notes
WVA	29115, 29116 29148, 29183	185	85	15	4	Top springs included Repair kit included
MAN	81508205085 81508206054					
MB	0004211010 0004211210 0014212510 0034201120 0034201220					

## 5.9 DISC BRAKE PADS

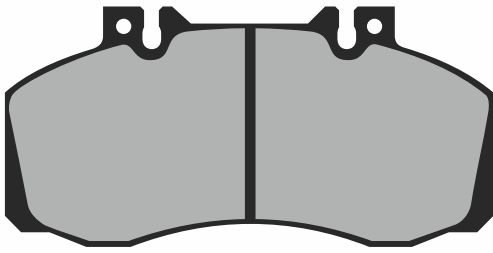

**PA26014**



Suitable for	Cross-ref.	 mm	 mm	 mm	Quantity, pcs/set	Notes
WVA MB	20835, 29835 0014201520 0024205720 0024206220 0034201520 0034207720 0044204820 6694200020 6694200120 6704202820	175	85	21,7	4	

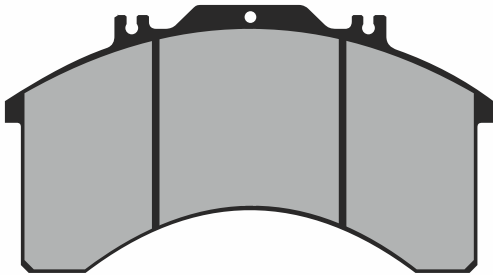

**PA26015**



Suitable for	Cross-ref.	 mm	 mm	 mm	Quantity, pcs/set	Notes
WVA IV	29011 1906191 1906459 2992479	228,4	125	25	4	Sensors included

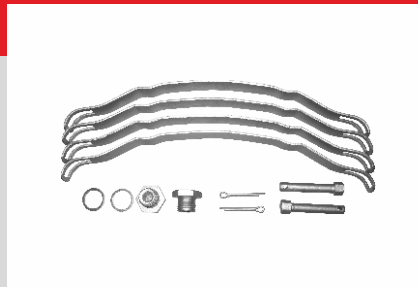
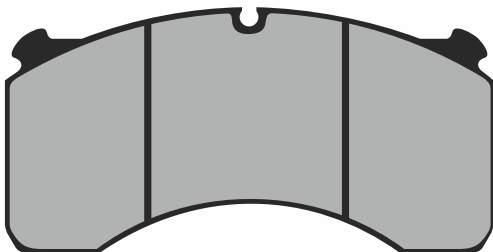

**A26016**  
Economy line  
only

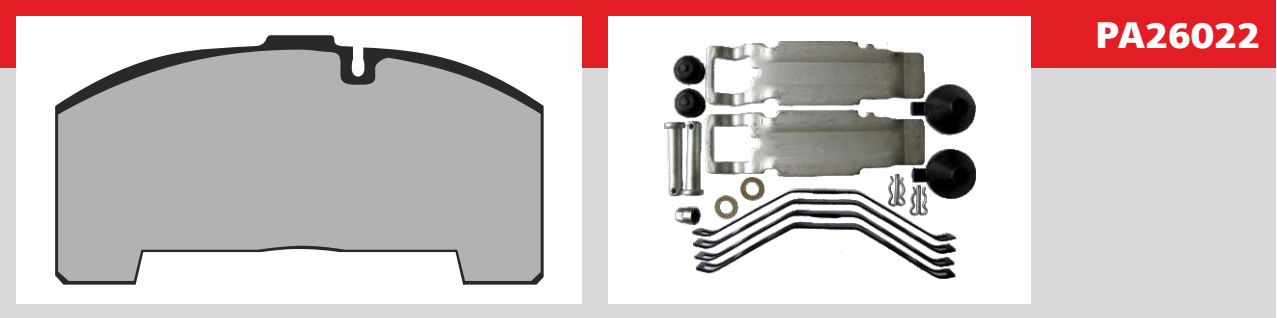

Suitable for	Cross-ref.	 mm	 mm	 mm	Quantity, pcs/set	Notes
WVA	29124	205,3	93,4	27	4	Top springs included
Meritor	15224835					Repair kit included





**PA26022**

Suitable for	Cross-ref.	 mm	 mm	 mm	Quantity, pcs/set	Notes
WVA	29171	210,2	107,8	30	4	Top springs included Repair kit included
BPW	0509290060 0509290080 0980106440 0980106950					
Meritor	MDP3171K					



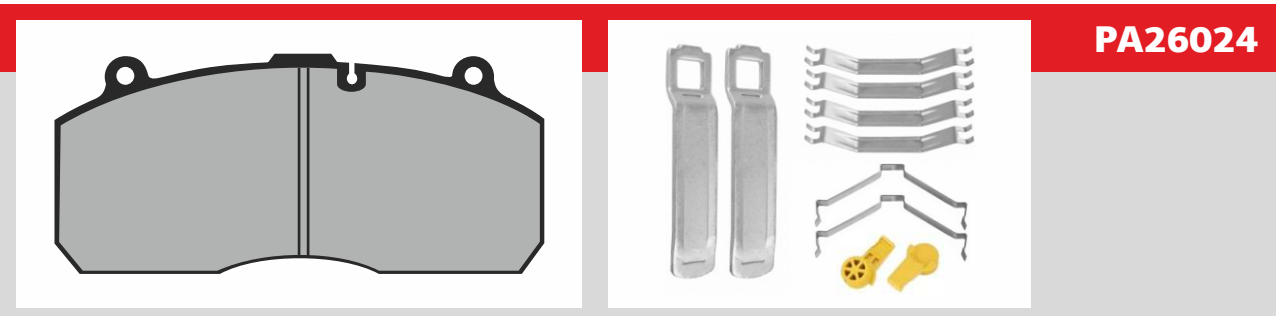

**PA26023**

Suitable for	Cross-ref.	 mm	 mm	 mm	Quantity, pcs/set	Notes
WVA	29279	217,5	107,6	30.8	4	Top springs included
MAN	81508205108 81508206065 81508206066					



**PA26024**

Suitable for	Cross-ref.	 mm	 mm	 mm	Quantity, pcs/set	Notes
WVA	29175	210	94	30	4	Top springs included Repair kit included
SAF	3057009600					

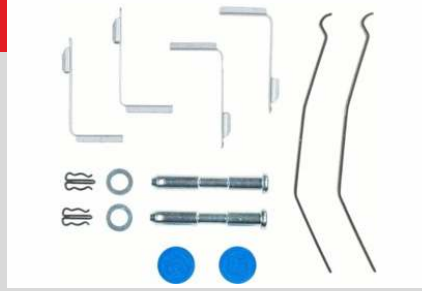
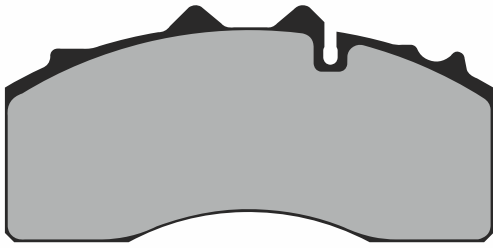

## 5.11 DISC BRAKE PADS

**PA26025**







5

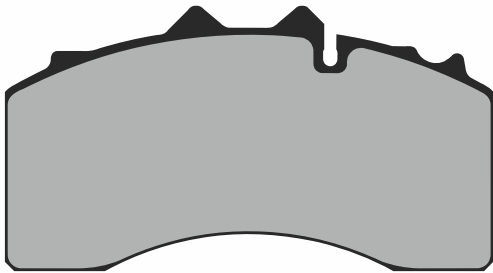

Suitable for	Cross-ref.	 mm	 mm	 mm	Quantity, pcs/set	Notes
WVA	29227	210,3	102	30	4	Top springs included Repair kit included
BPW	0509290120 0900061790 0980107550 0980107940					



**PA26026**



Suitable for	Cross-ref.	 mm	 mm	 mm	Quantity, pcs/set	Notes
WVA	29228	210,8	114,5	30	4	Top springs included Repair kit included
BPW	0509290130 0980107570 0980107960 0980107971					

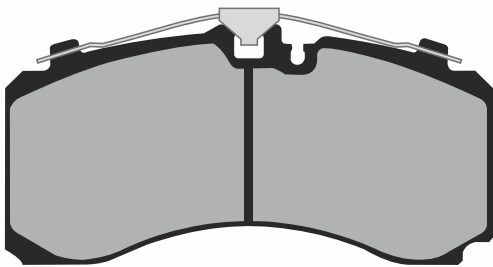

**PA26027**

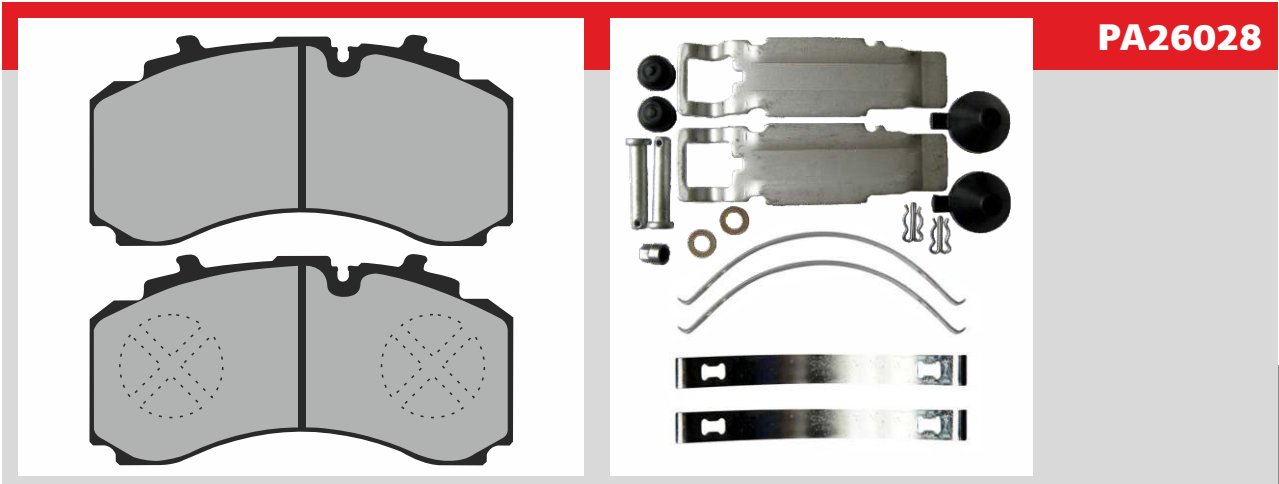

Suitable for	Cross-ref.	 mm	 mm	 mm	Quantity, pcs/set	Notes
WVA	29318	215	107	31,2	4	Top springs included Repair kit included



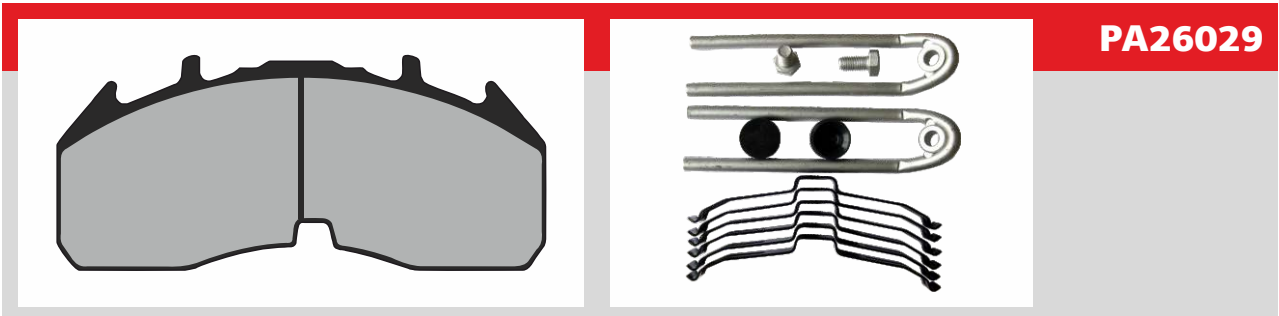

**PA26028**

Suitable for	Cross-ref.	 mm	 mm	 mm	Quantity, pcs/set	Notes
WVA SCH BPW	29328 1178243 K108020K50	215	109	30	4	Top springs included Repair kit included



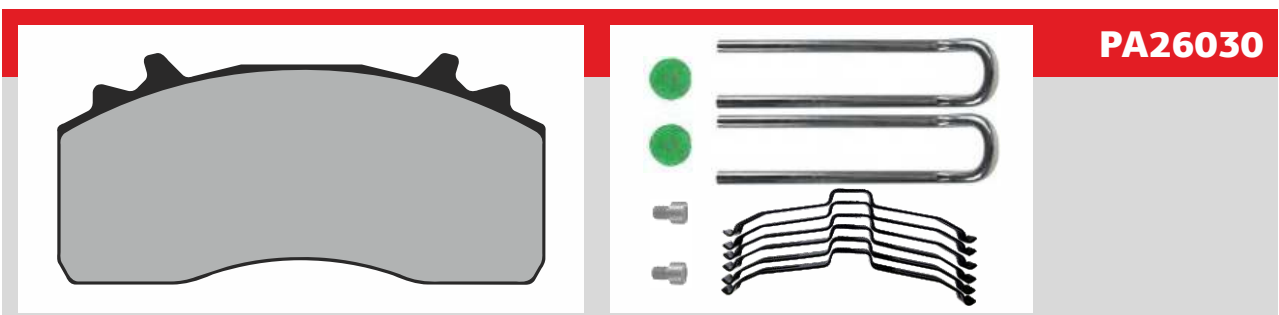

**PA26029**

Suitable for	Cross-ref.	 mm	 mm	 mm	Quantity, pcs/set	Notes
WVA SC	29332 2127745 2272502 20190319	249,5	111	29,2	4	Top springs included Repair kit included







**PA26030**

Suitable for	Cross-ref.	 mm	 mm	 mm	Quantity, pcs/set	Notes
WVA MB	29315 0084206320 0084206420	220,5	104,6	29	4	Top springs included Repair kit included

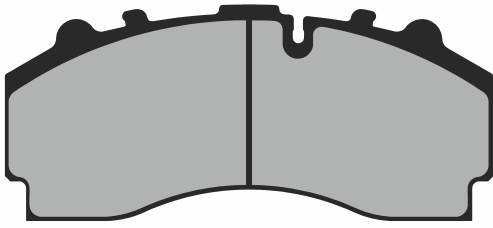
## 5.13 DISC BRAKE PADS

**PA26031**







Suitable for	Cross-ref.	 mm	 mm	 mm	Quantity, pcs/set	Notes
WVA	29331	247,5	109,5	30	4	Top springs included Repair kit included
SC	2271804 2325212 2325213					

5

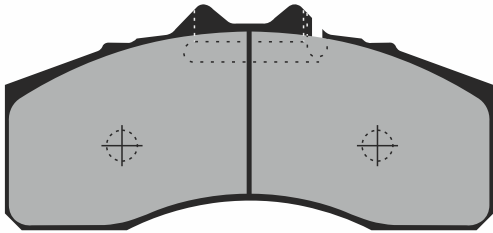





**PA26032**

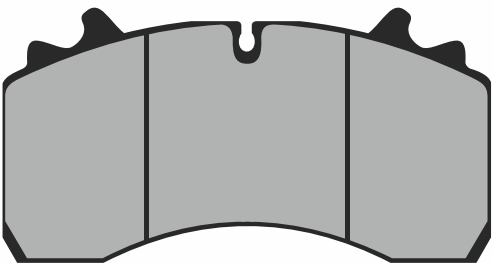

Suitable for	Cross-ref.	 mm	 mm	 mm	Quantity, pcs/set	Notes
WVA	29267	246,8	115	30	4	Top springs included Repair kit included
BPW	0980107980					



**PA26033**

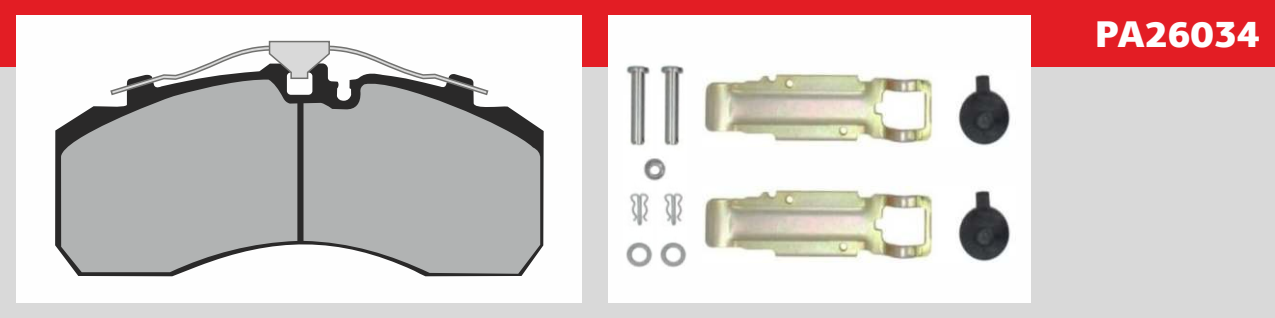

Suitable for	Cross-ref.	 mm	 mm	 mm	Quantity, pcs/set	Notes
WVA	29162	210,5	109,5	31	4	Top springs included Repair kit included
SCH	1101449, 1195232					
SAF	3057008400					
Meritor	MDP3162					



**PA26034**

Suitable for	Cross-ref.	 mm	 mm	 mm	Quantity, pcs/set	Notes
WVA	29278	247,5	107,7	30	4	Top springs included Repair kit included
MN	81508206091					

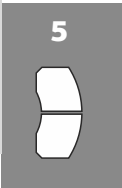

## 5.15 DISC BRAKE PADS

5

